



ref. 596 - SMOOTH_fountain

MATERIAL_CONCRETE + STAINLESS STEEL
 CONCRETE FINISHING_HYDROFUGATED
 STAINLESS STEEL FINISHING_BRUSHED
 COLOR_NATURAL CONCRETE
 WEIGHT_100KG
 FIXING_GROUND INCORPORATE

SiT

TECHNICAL DETAILS scale 1/20

+ FIXING POINT

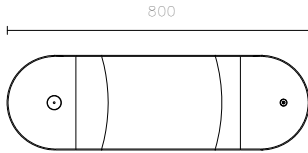

TOP VIEW

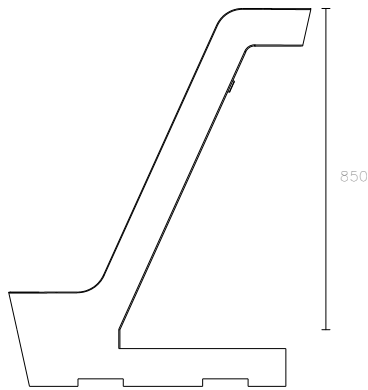

LATERAL VIEW

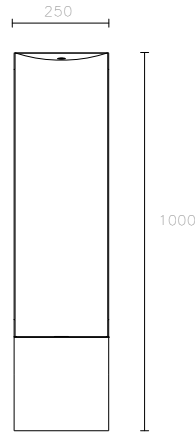

FRONT VIEW

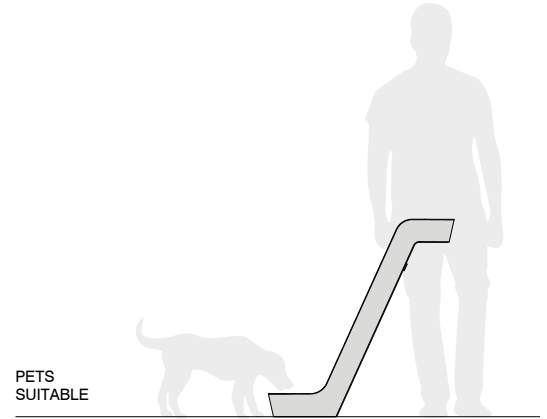

PETS
SUITABLE

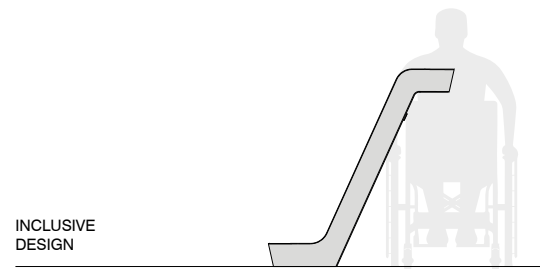

INCLUSIVE
DESIGN

ELEVATION scale 1/40

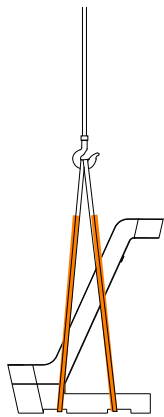

PLACEMENT OF POLYESTER STRAPS ON THE INFERIOR LIFTING APERTURES WITH PROTECTION ON CONTACT SURFACES

FIXING scale 1/20

GROUND INCORPORATE

01_wastepipe pvc 32 mm
 02_water supply pex 16 mm
 03_emergency tap / water flow regulato

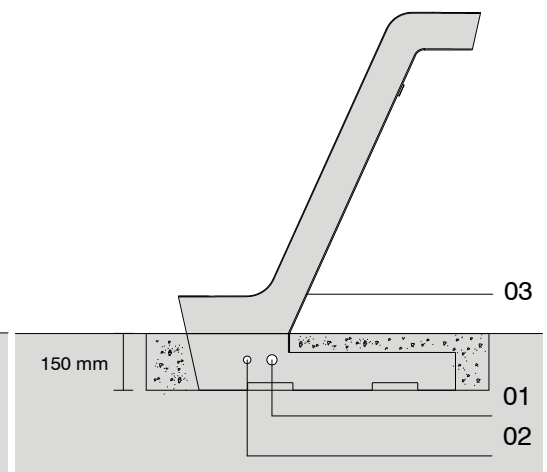

www.aboutsit.com . info@aboutsit.com

Av. Nossa Sra. da Vitória, 8 . S. Jorge | 2480-062 Porto de Mós .
 Portugal | tel. +351 244 482 525 | GPS: 39°37'50.71''N 8°51'10.44''W